

MV40 系列波纹管式计量阀

MV40 SERIES METERING BELLOWS VALVES



特点 Features

- 波纹管密封
- 带位置锁定功能
- 调节行程: 6 圈
- 旋转六圈能将阀打开到最大流量
- 接口: GENLOK, FSR, TW (参阅尺寸规格表)
- 标准安装法: 面板式安装和底部安装

材质 Materials

- 母体: 316L, 316L VAR
- 波纹管: 316L
- 阀杆: 316

性能 Specifications

- 工作压力: 700 psi (48.3 bar)
- 工作温度: -28°C ~ 315°C (-20°F ~ 600°F)
- 流量系数: Cv=0.02
- 外泄漏率: $\leq 4 \times 10^{-9}$ atm cc/sec He

安装尺寸图 Dimension

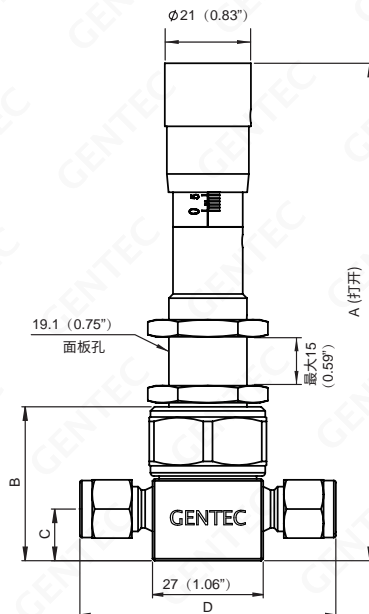

型号 Model	通经 Orifice mm(in.)	CV	连接形式 Connection Type		尺寸 mm(in.) Dimension				
			进气 Inlet	出气 Outlet	A(打开)	B	C	D	
SL-MV40M-TF4			1/4" GENLOK					12.7 (0.5")	62.5 (2.46")
SL-MV40M-TF6M			6mm GENLOK						
SL-MV40M-VM4	1.4(0.06")	0.02	1/4" FSR (M)		122 (4.8")	37.8 (1.49")		11.2 (0.44")	56.9 (2.24")
SL-MV40M-TW4			1/4" Tube Weld						44.2 (1.74")
SL-MV40M-VSM4			1/4" FSR (M)					12.7 (0.5")	69.2 (2.72")
SL-MV40M-VSF4			1/4" FSR (F)						

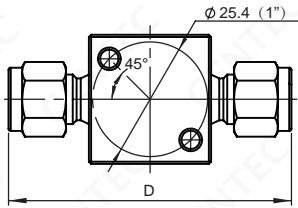

TF 卡套接头

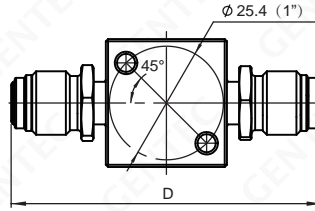

VSM 外螺纹接头

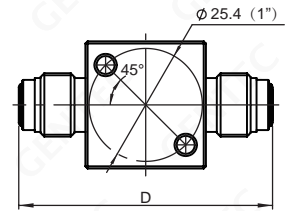

VM 外螺纹接头

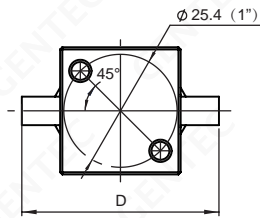

TW 对焊连接

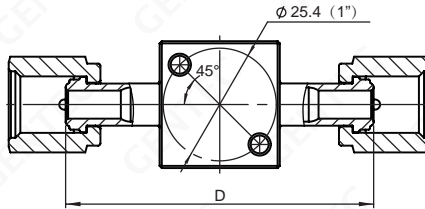

VSF 内螺纹接头

注：尺寸单位为 mm (in.)

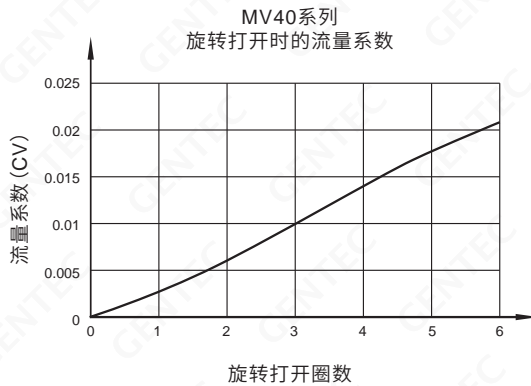
流量系数图 Flow Chart

订购指南 Ordering Information

Ex: SL	- MV40	M	- TF4	- E
母体 Body	系列号 Series Number	旋钮样式 Knob Type	进气/出气连接 Inlet/Outlet Connection	流道表面 Wetted Surface Roughness
SL: 316L SLV: 316L VAR	MV40	M: 手动带刻度	TF4: 1/4" GENLOK TF6M: 6mm GENLOK VM4: 1/4" FSR (M) TW4: 1/4" Tube Weld VSM4: 1/4" FSR (M) VSF4: 1/4" FSR (F) 其他形式接头可供选择	无: 15µin E: 10µin

